



# 由機電工程到機器人於生活與 產業之應用

**TALK: 0319**

黃宜正 彰化師範大學機電工程學系  
美國哥倫比亞大學機械工程博士

# What's Mechatronics

- Mechatronics = "Mechanical" + "Electronics"
- Elctromechanics = "Electronics/Electrical [EE]" + "Mechanics"

# Life is good

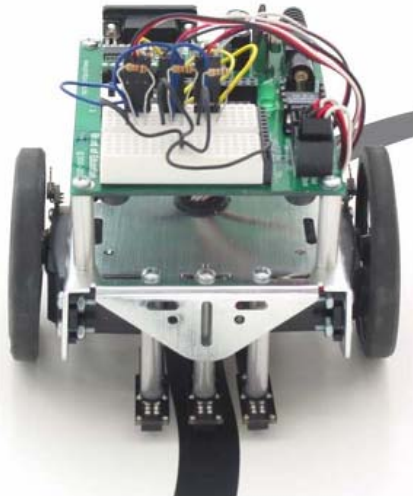
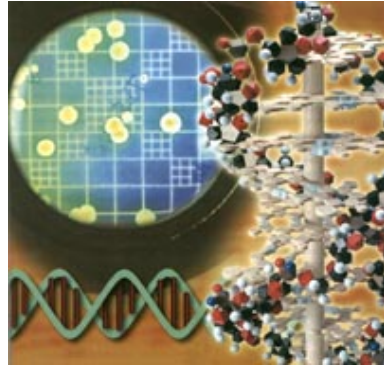

HOBBLE RADIO & CLOCK  
IDEA IN.  
mydoab.com



# Your Dream ! How to do it ?



# Cad Design : curvature, thermo

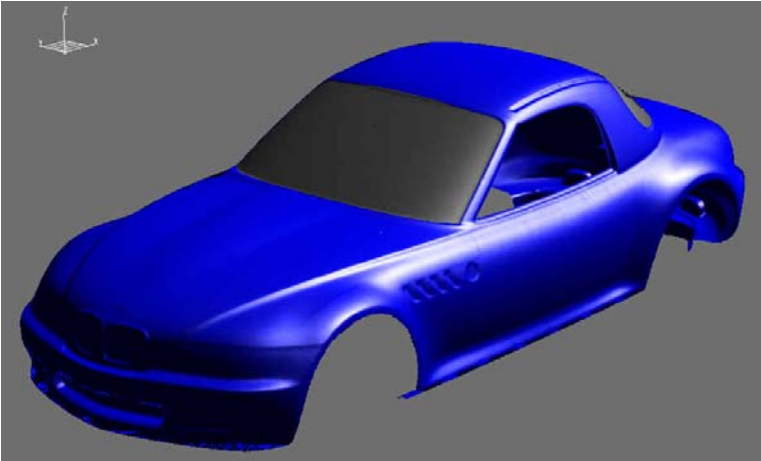
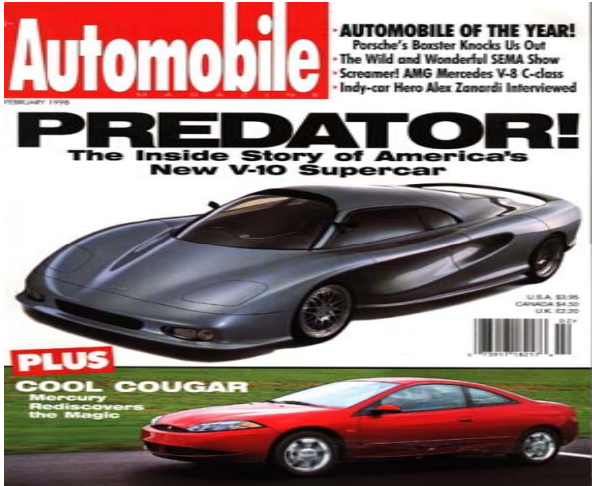
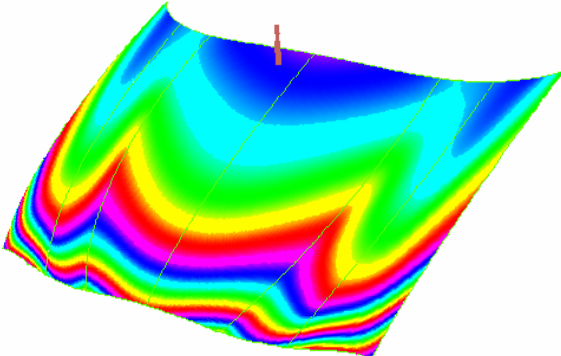
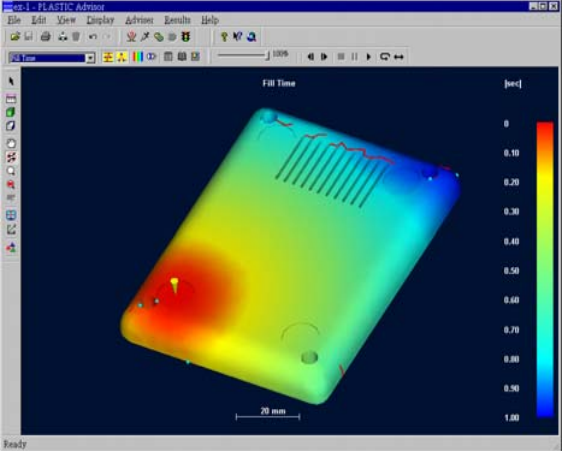

# CAD → Manufacture

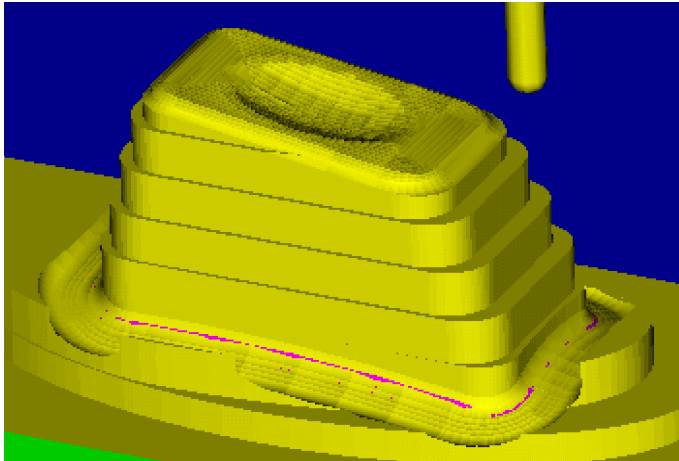

# CAM → Machine Center

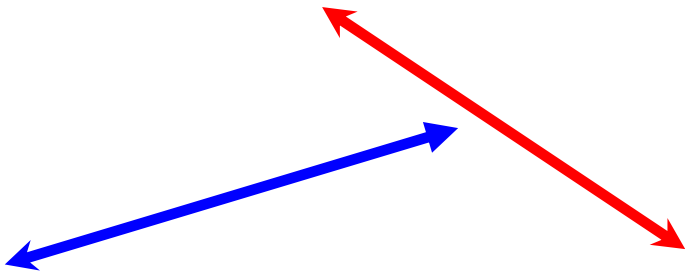
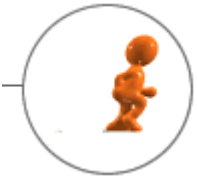

# CAM → Machine Center



# CAD Analysis → CAE

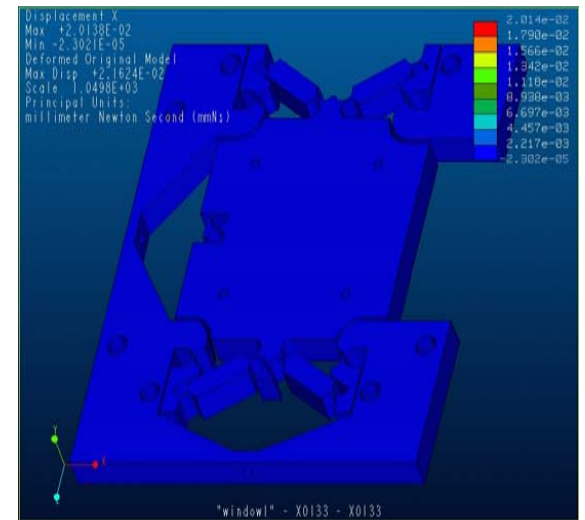
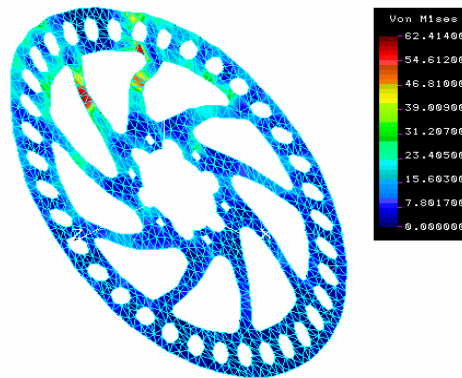
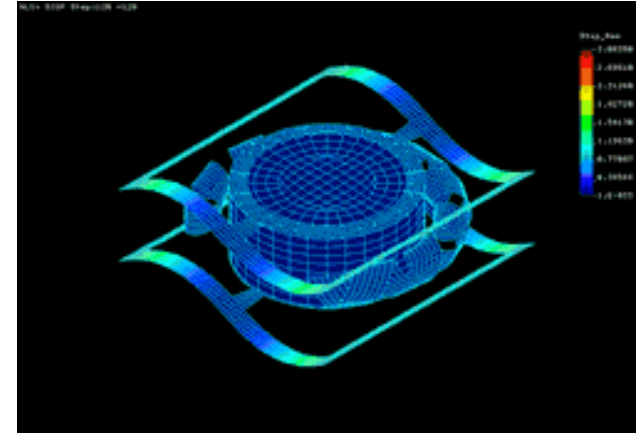
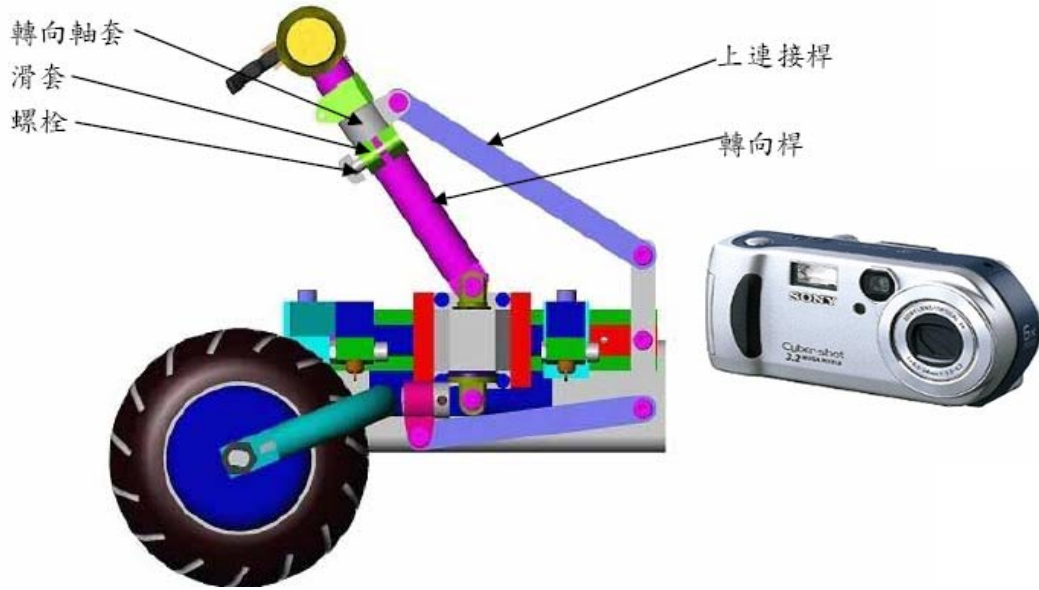

# Power & Dynamic motion

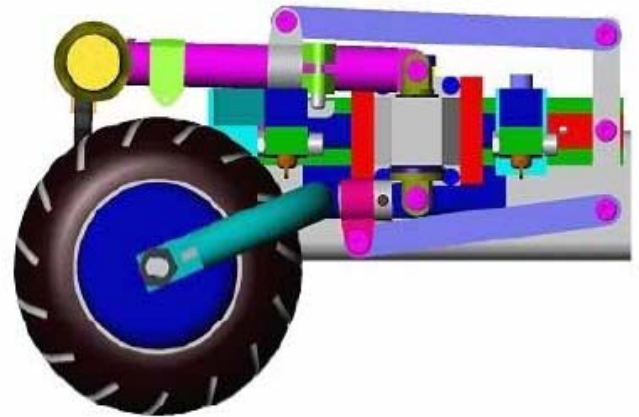
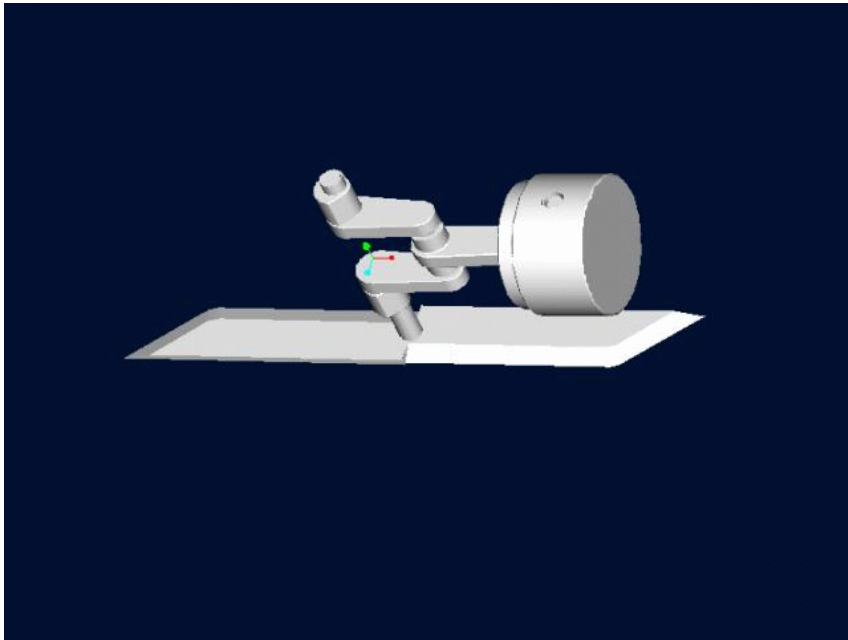

# Realizations

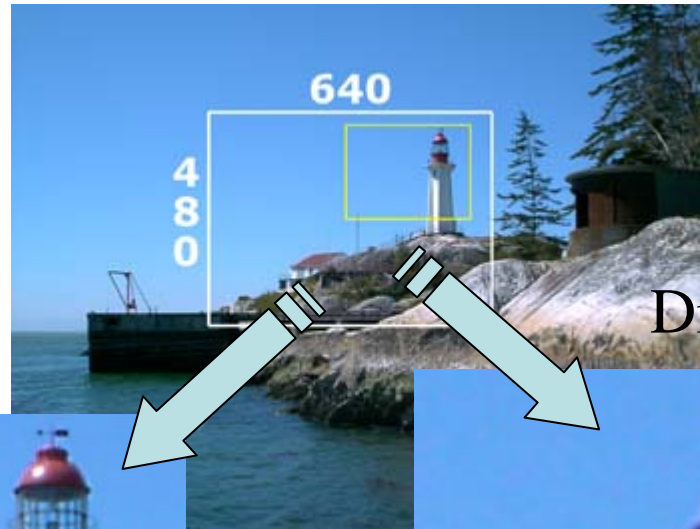

Optical Zoom

Digital Zoom



**No degradation  
of image quality**



**Severe degradation  
of image quality**

# Honda

- Mechanical parts
- Mechanism
- Power
- Motion

# Mechanical + Electronics → Nerve

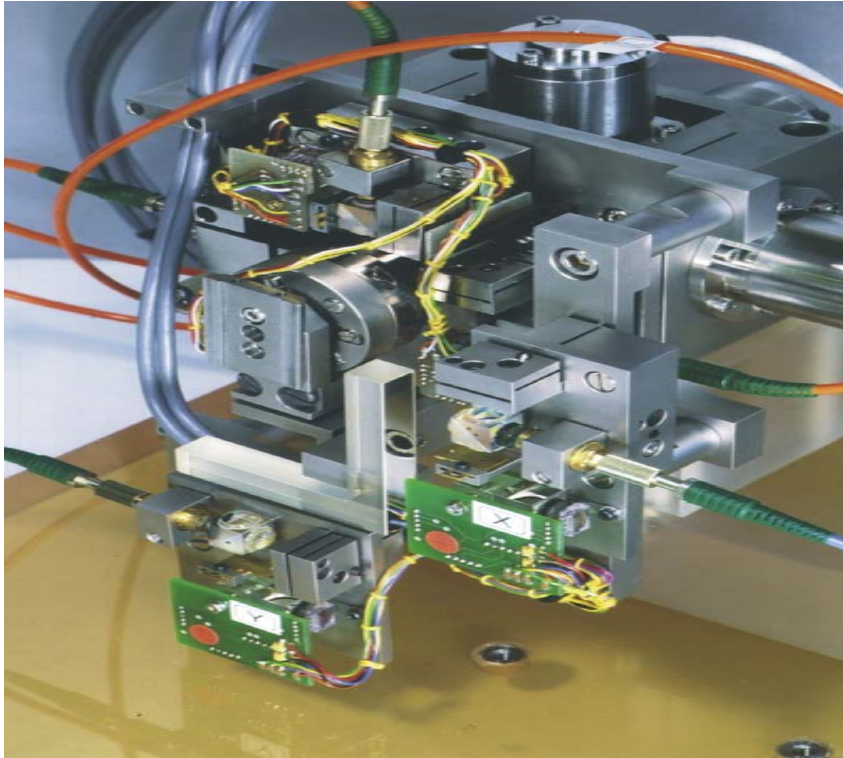

- Robotics
- Imagination → Your Dream

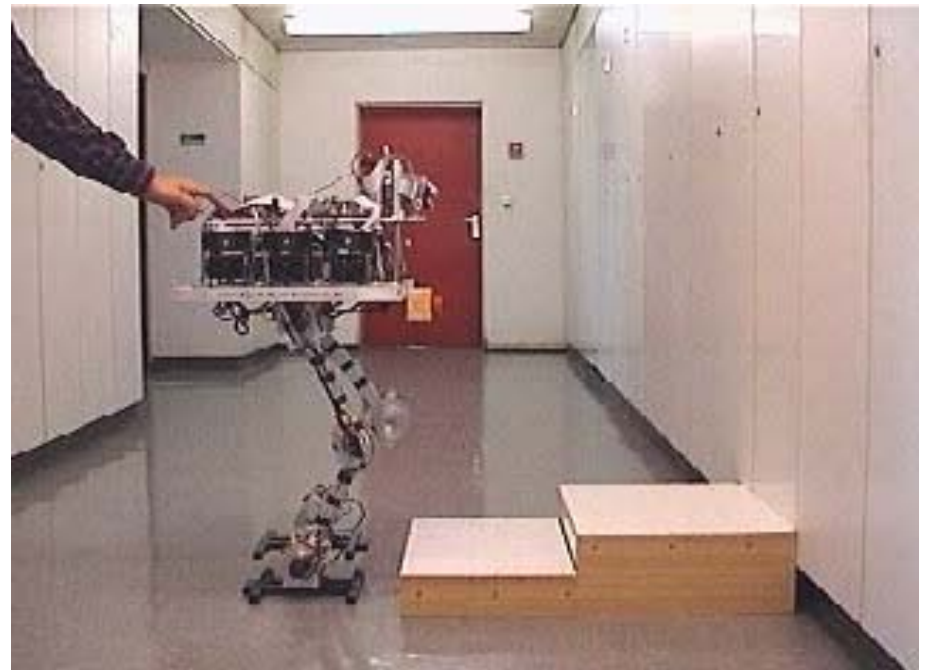
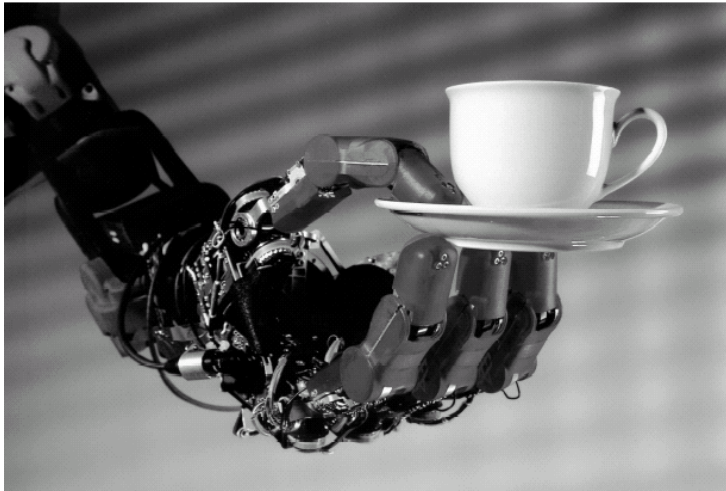

# SEGWAY → Your free way

- **Segway Human Transporter**
- **Maximum speeds:** 6 mph (Beginner key), 8 mph (Sidewalk Operation key), 12.5 mph (Open Environment key)
- **Weight:** 83 pounds (38 kg)
- **Motors:** two (one per wheel) brushless, independent, 2-horsepower DC servo motors and helical gearboxes (24:1 gear ratio)



# Vision Inspection Systems

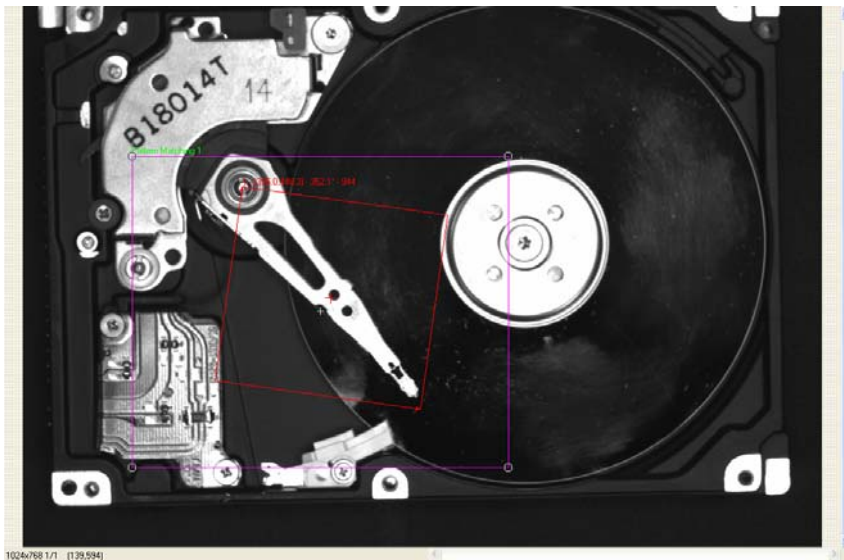
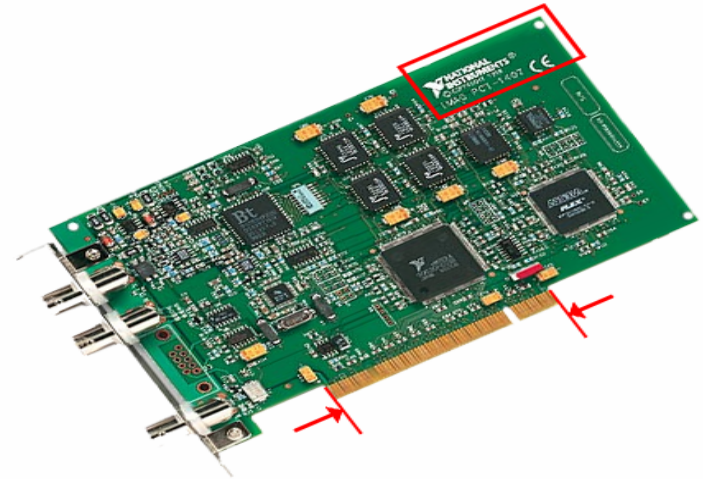

1026/758 1/1 (139,594)

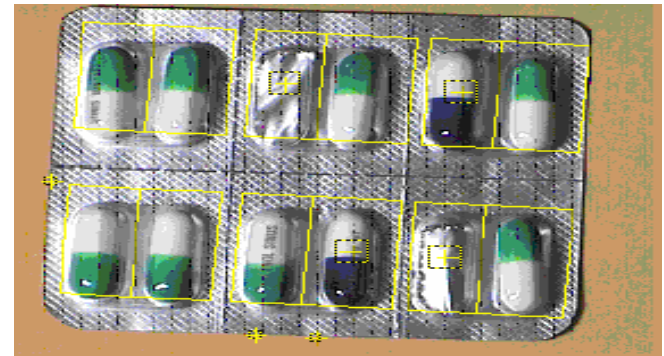

# Electronics /wafer

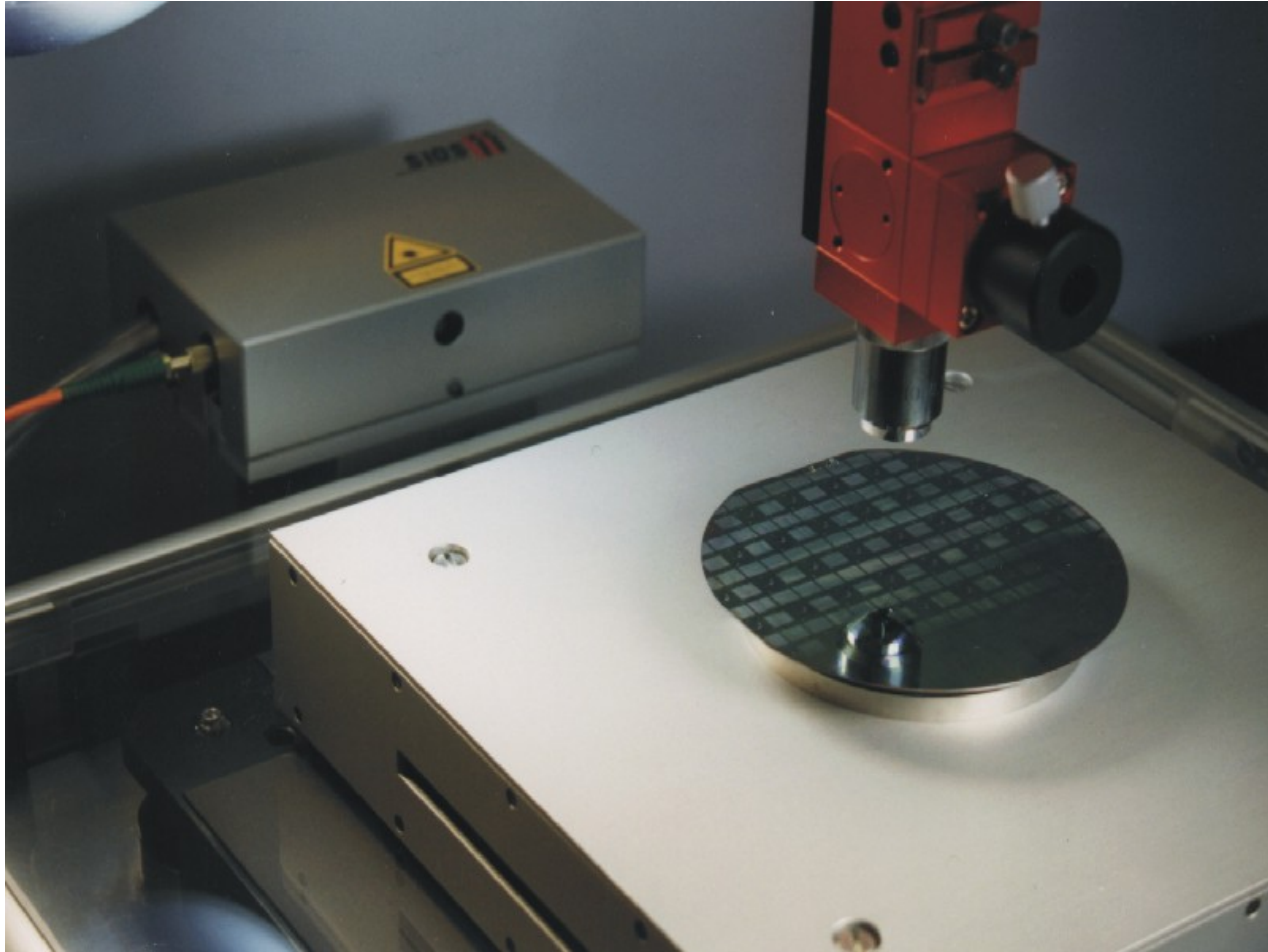

# Motion in micro meter (our lab)

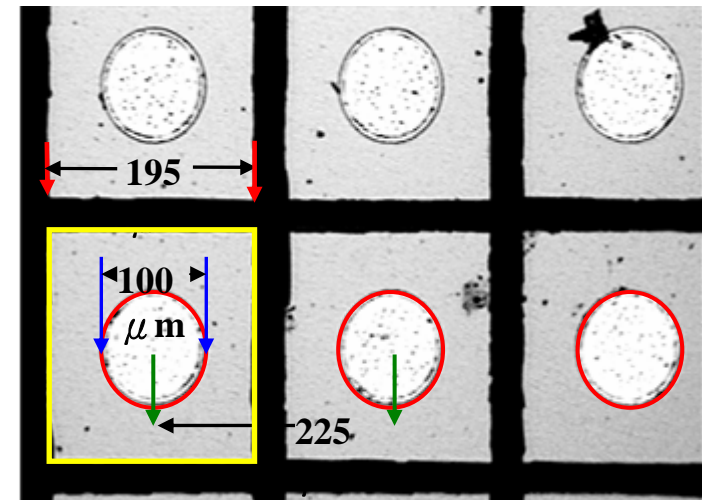
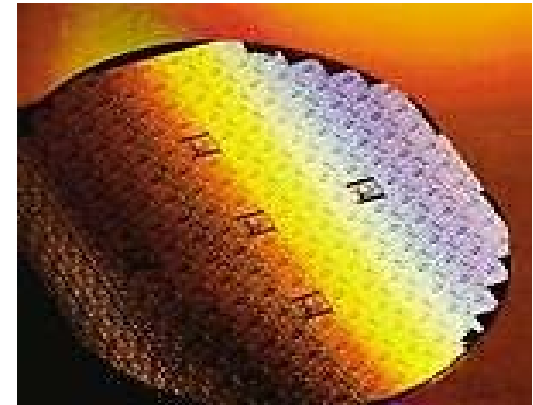
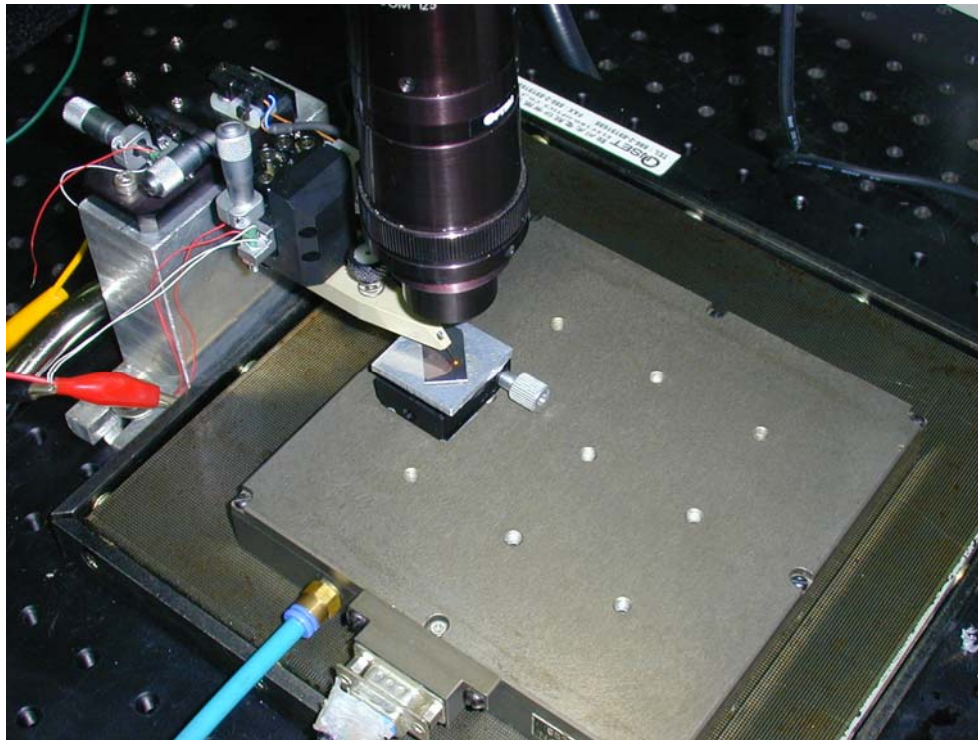

Human hair diameter ?  
60-70um

# Motion in ultra fine u/nano meter

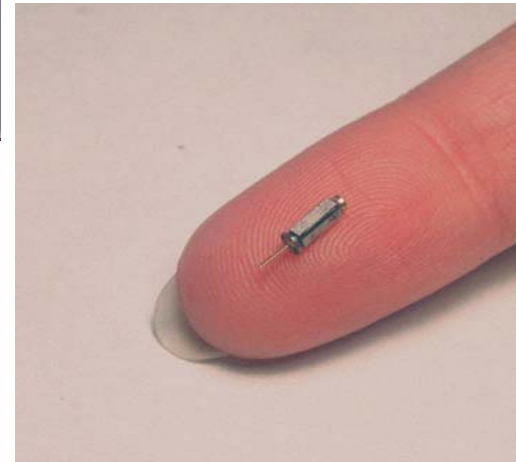

Equipment for  
**Nanopositioning**

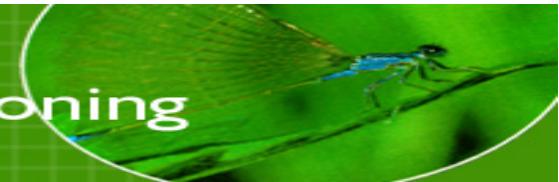

# Human and Intelligent Machine



# Sony → Entertainment

QRIO (世界第一個會跑步、跳舞的機器人)

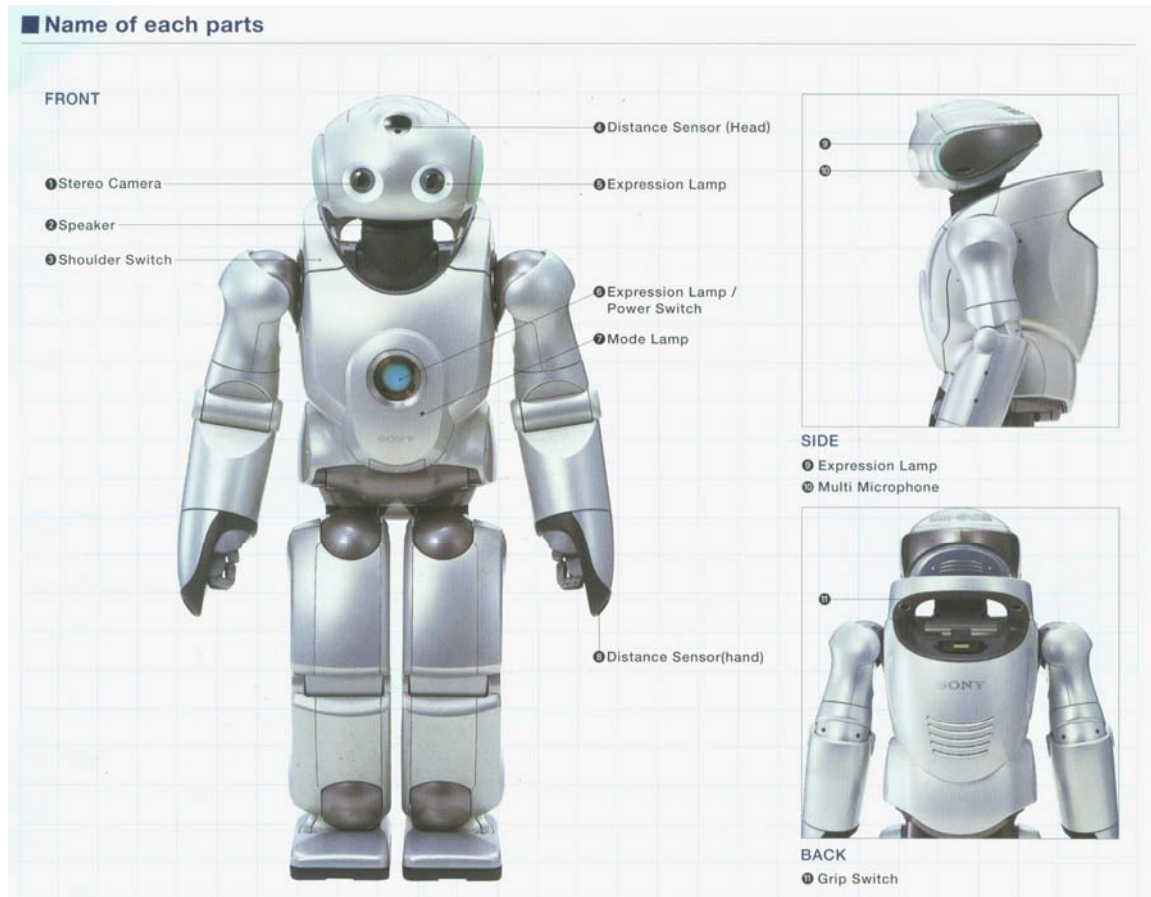

# TOYOTA

- How to do the human intelligence ?
- Here we go !

# Industrial Robots: Show time !

- Fast Moving (created by Philips 15 years ago): How it works ?
- ABB Robots Automation for CRT

# Can you Keep a Secret ?

- Before Commercial : designing and test
- Human with Robots
- Intelligent Enough ?
- More Compliance !
- Emotion ?

# Conclusion

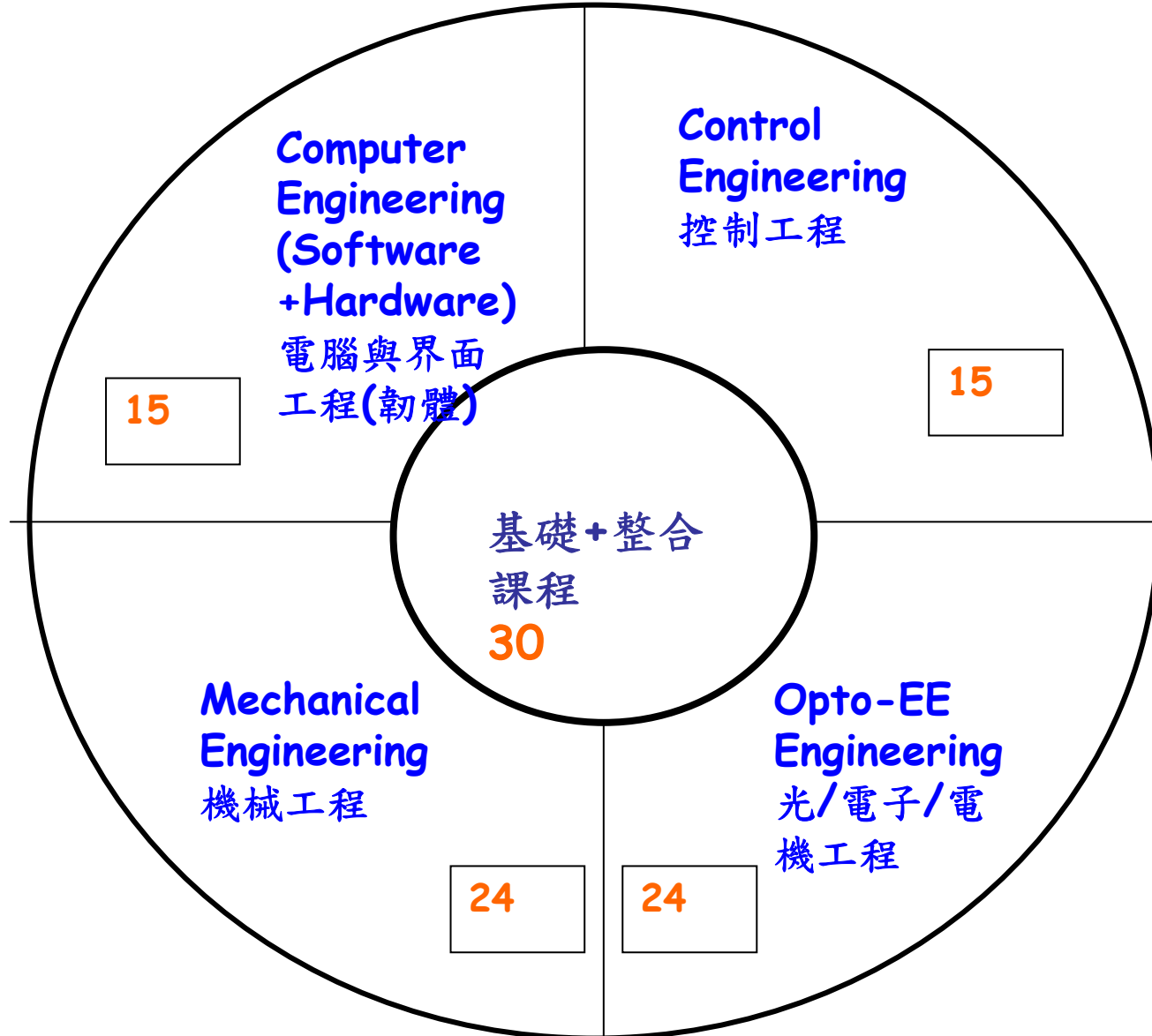

# THE END

THANKS !

Questions ?

Examination:

