

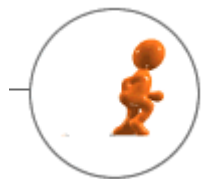

黃宜正 彰化師範大學機電工程學系  
教授兼工學院院長  
美國哥倫比亞大學機械工程博士



# What's Mechatronics

- Mechatronics = "Mechanical" + "Electronics"
- Elctromechanics = "Electronics/Electrical [EE]" + "Mechanics"

# 綜觀機器”人”

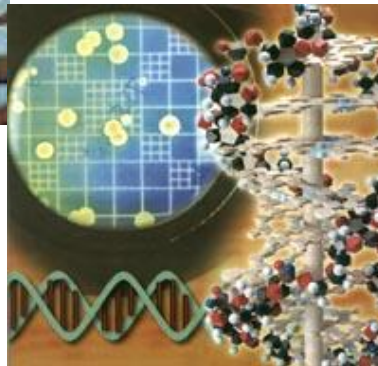

HOBBLE RADIO & CLOCK  
IDEA IN.  
mydoob.com



# Your Dream ! How to do it ?



# Cad Design : curvature, thermo

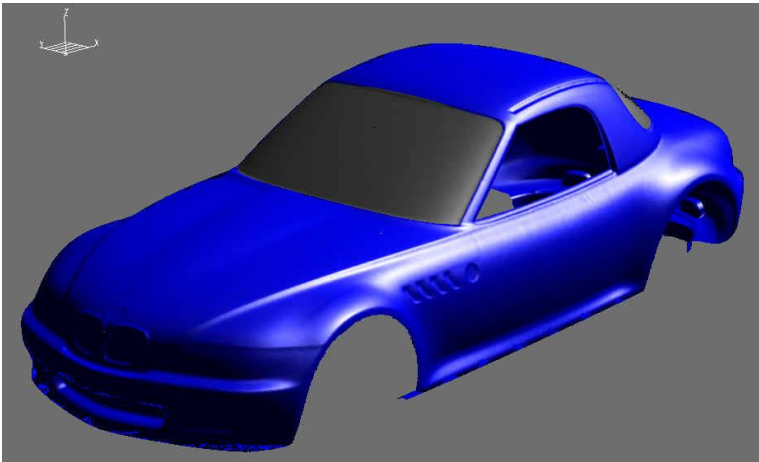
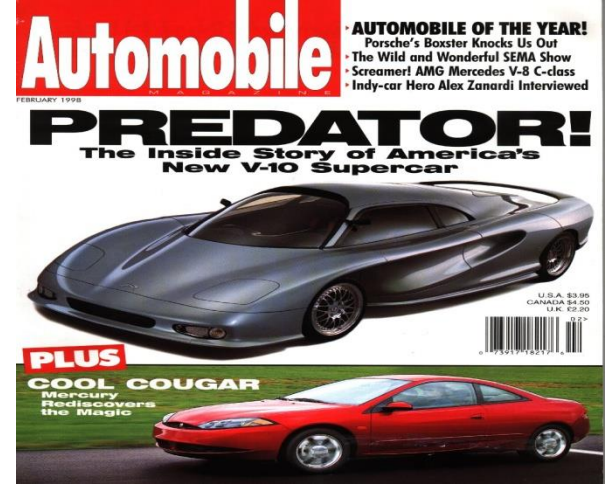
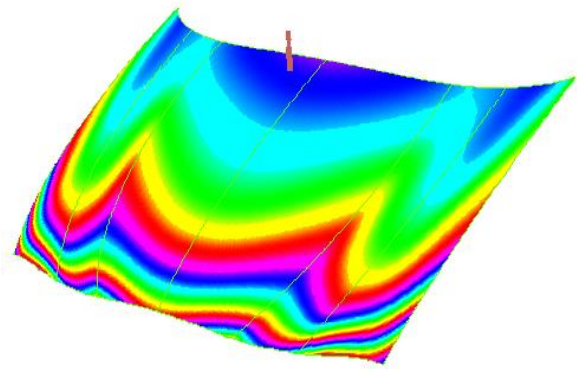
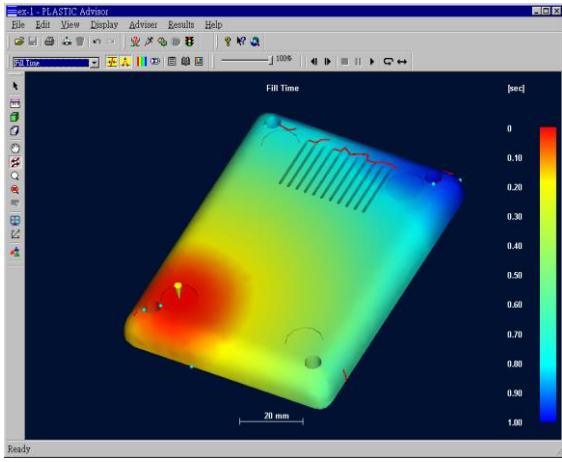

# CAD → Manufacture

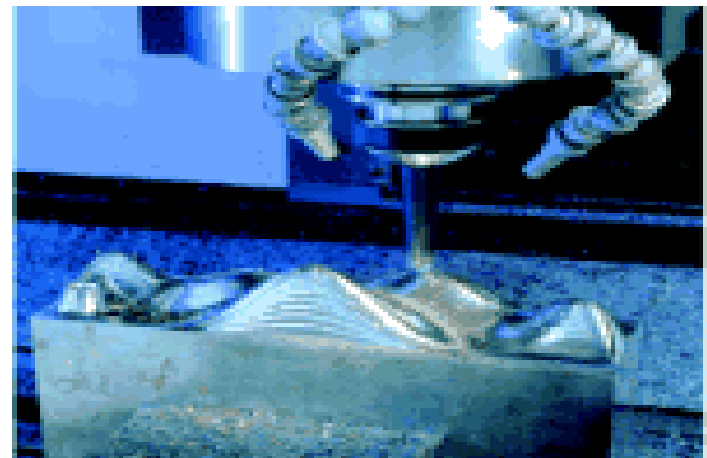
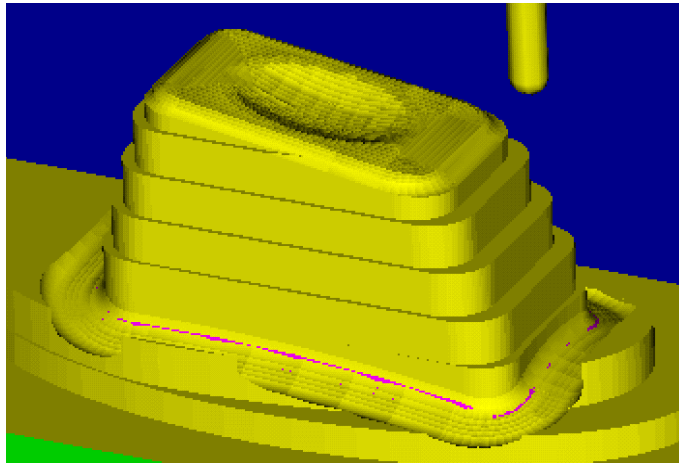

# CAM → Machine Center

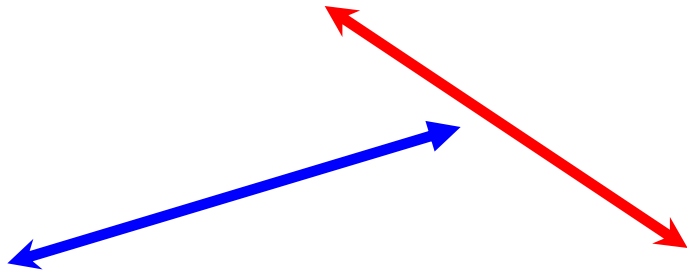
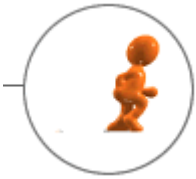

# CAM → Machine Center

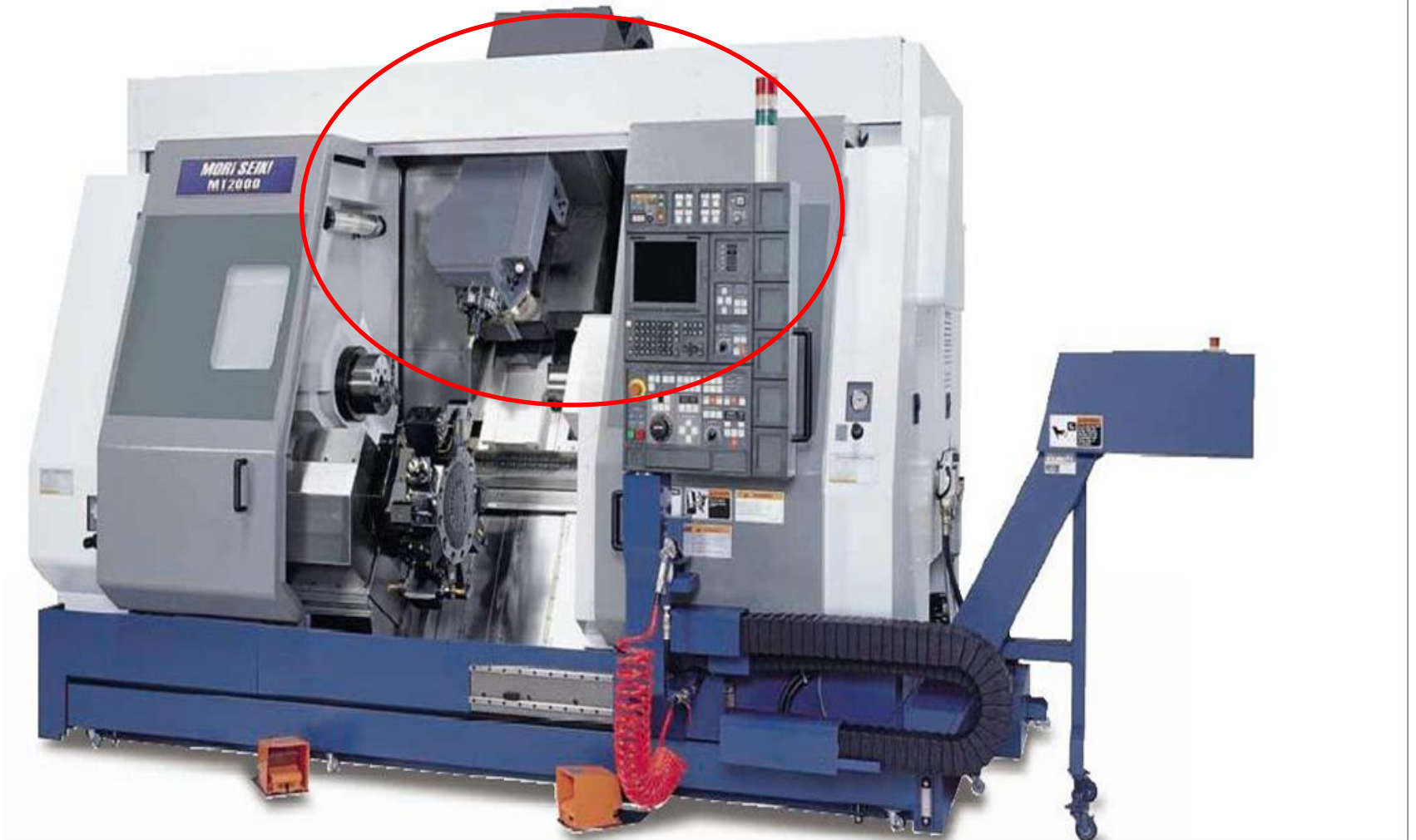

# CAD Analysis → CAE

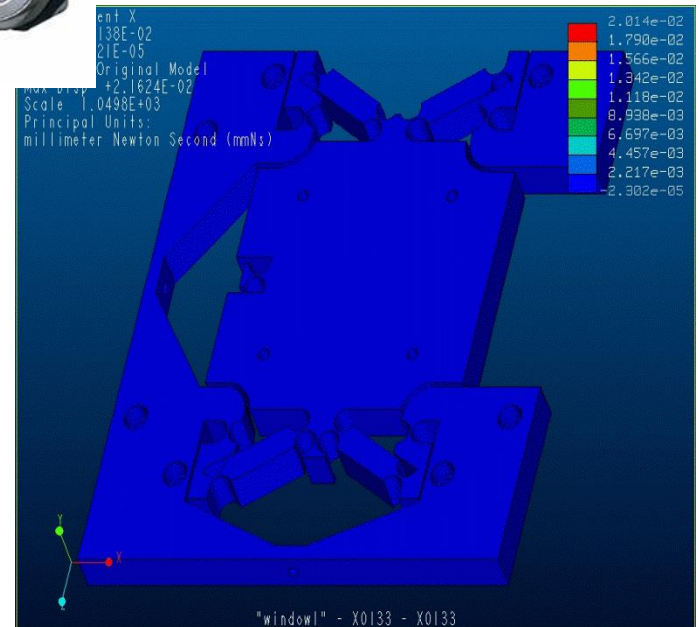
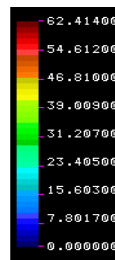
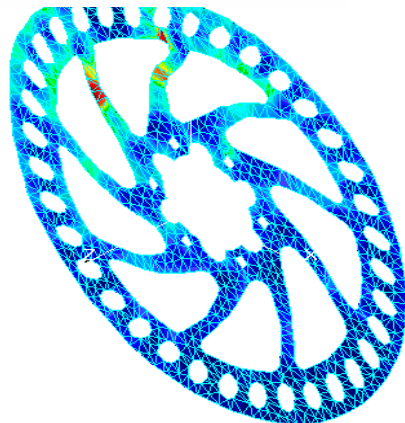
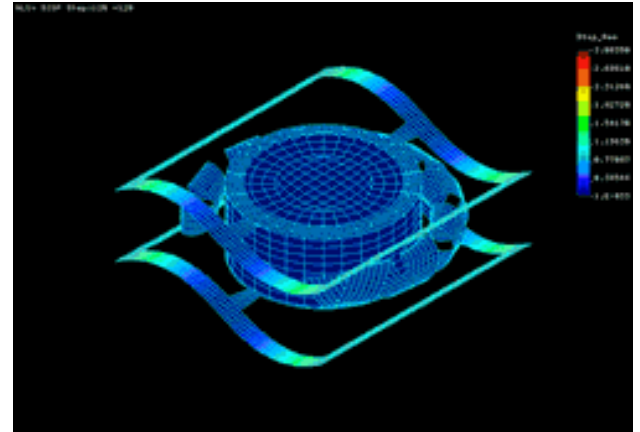
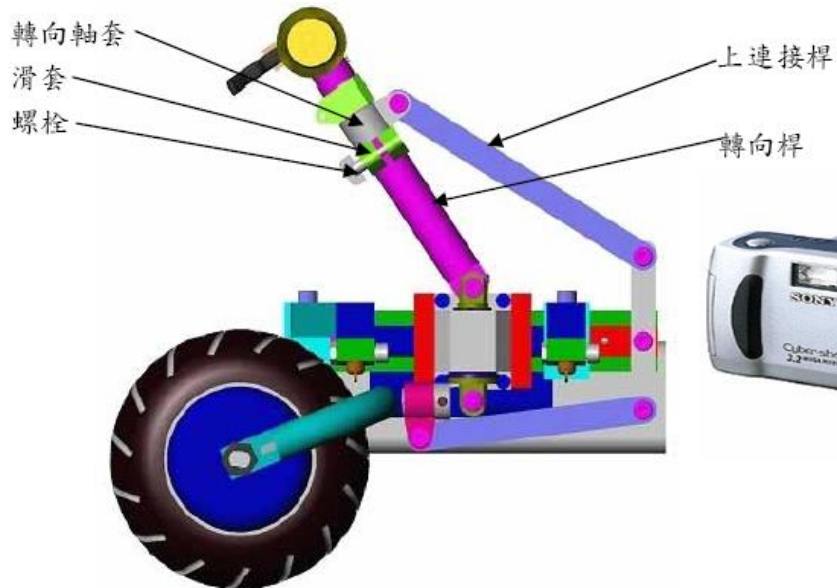

# Power & Dynamic motion

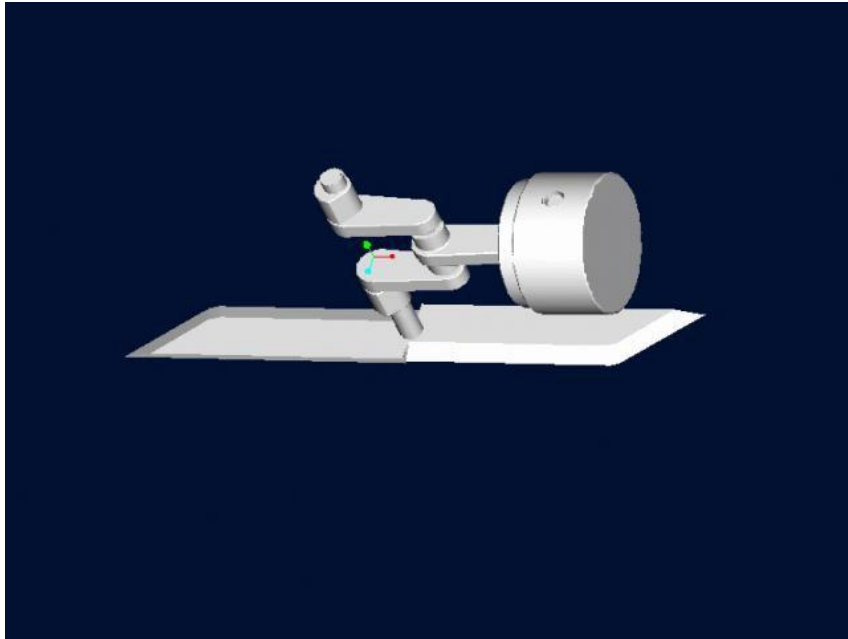

cutmachine1.exe

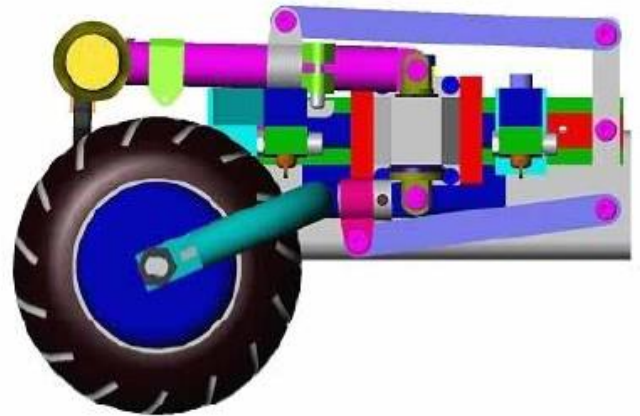

# Realizations

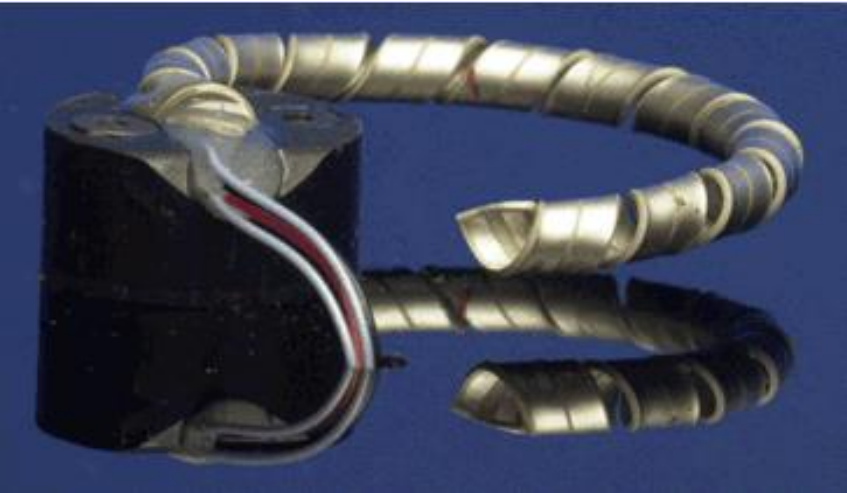

Optical Zoom

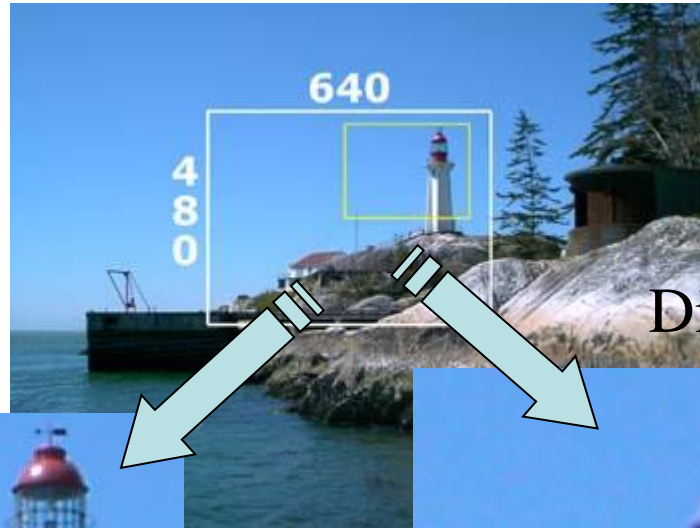

Digital Zoom



No degradation of image quality



Severe degradation of image quality



# Honda

- Mechanical parts
- Mechanism
- Power
- Motion

# Mechanical + Electronics → Nerve

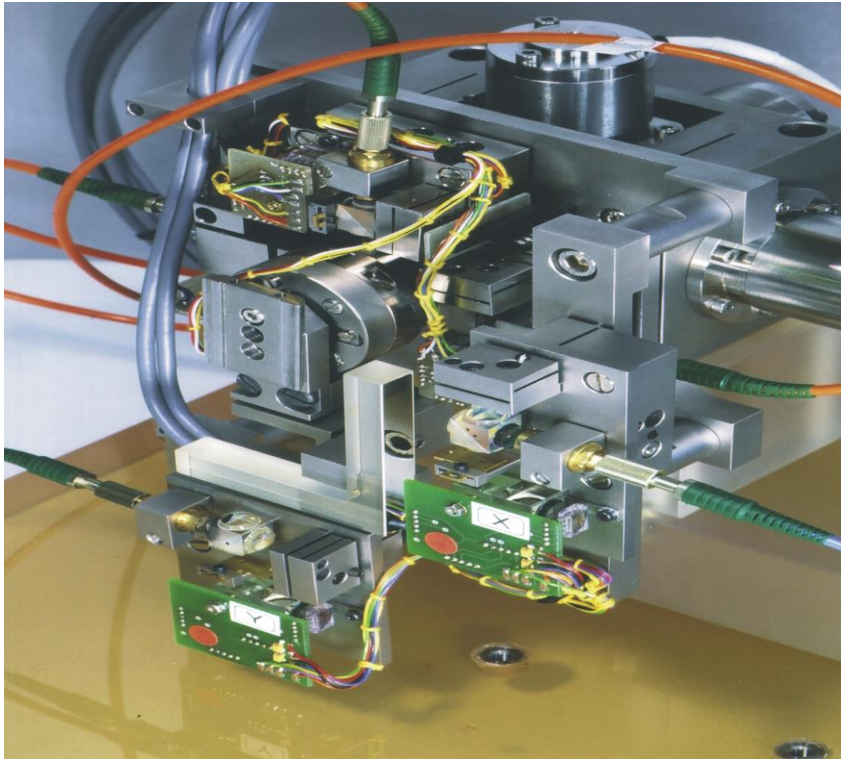

- Robotics
- Imagination → Your Dream

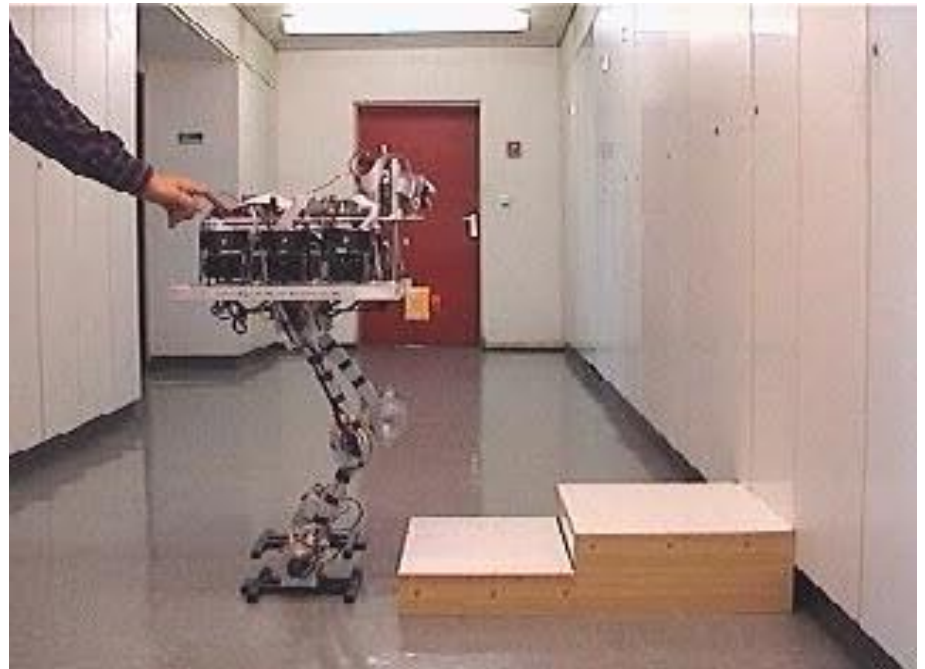

# SEGWAY → Your free way

- **Segway Human Transporter**
- **Maximum speeds:** 6 mph (Beginner key), 8 mph (Sidewalk Operation key), 12.5 mph (Open Environment key)
- **Weight:** 83 pounds (38 kg)
- **Motors:** two (one per wheel) brushless, independent, 2-horsepower DC servo motors and helical gearboxes (24:1 gear ratio)



# Vision System

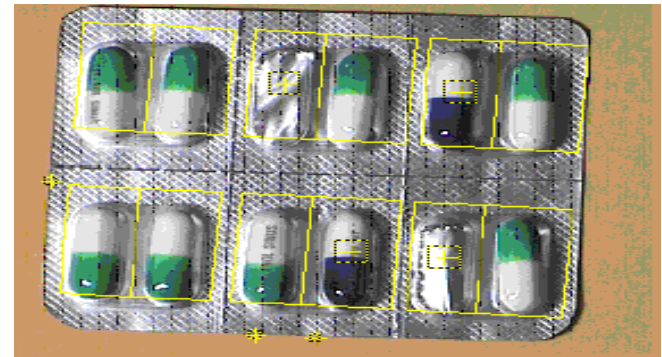
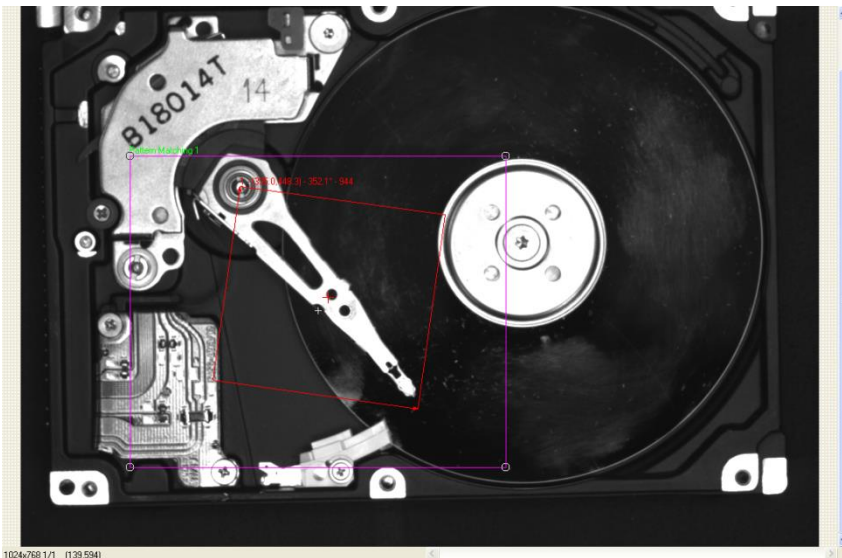
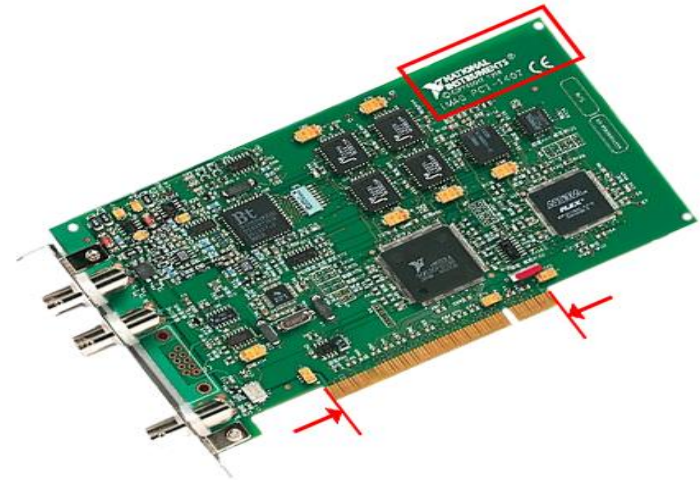

# Electronics

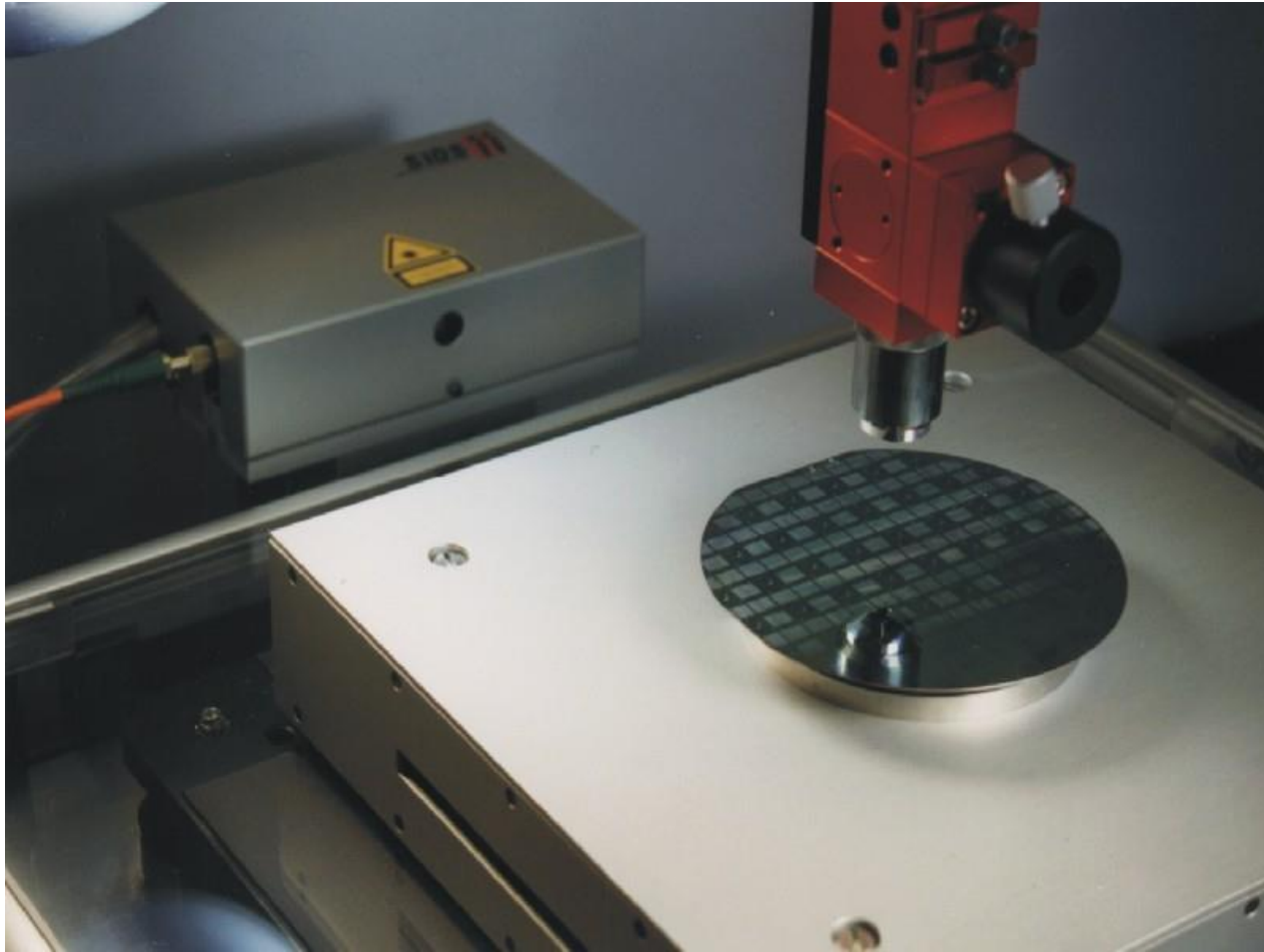

# Motion in micro meter

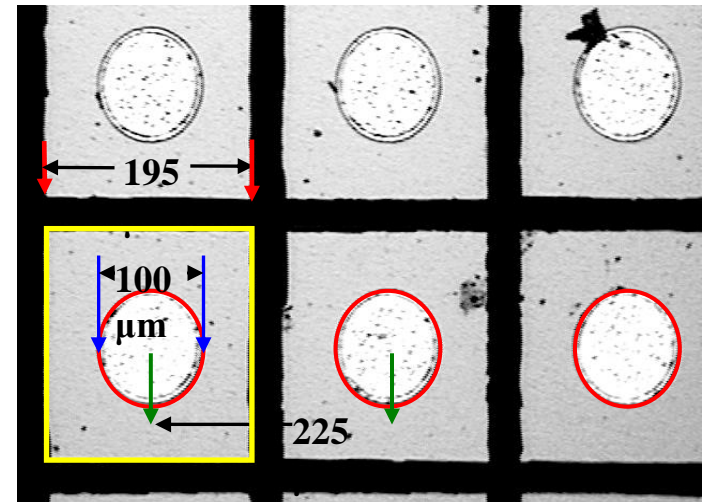
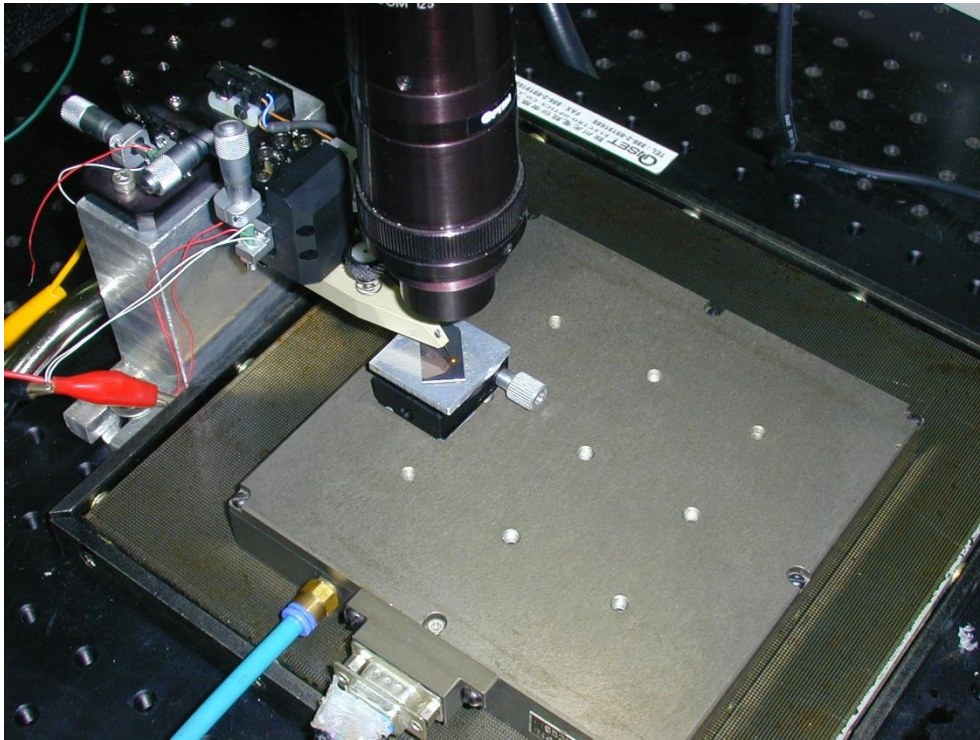

Human hair diameter ?

# Motion in ultra fine u/nano meter

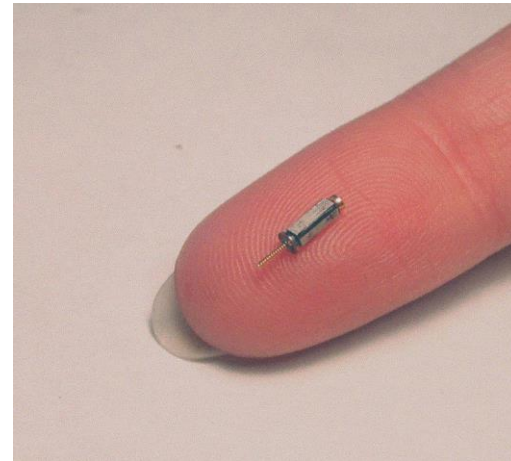
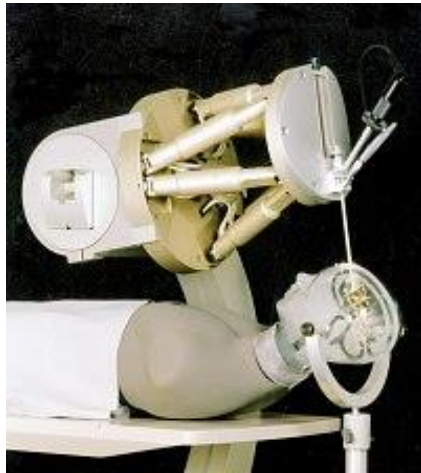

Equipment for  
**Nanopositioning**



# Human and Intelligent Machine



# Sony → Entertainment

QRIO (世界第一個會跑步、跳舞的機器人)

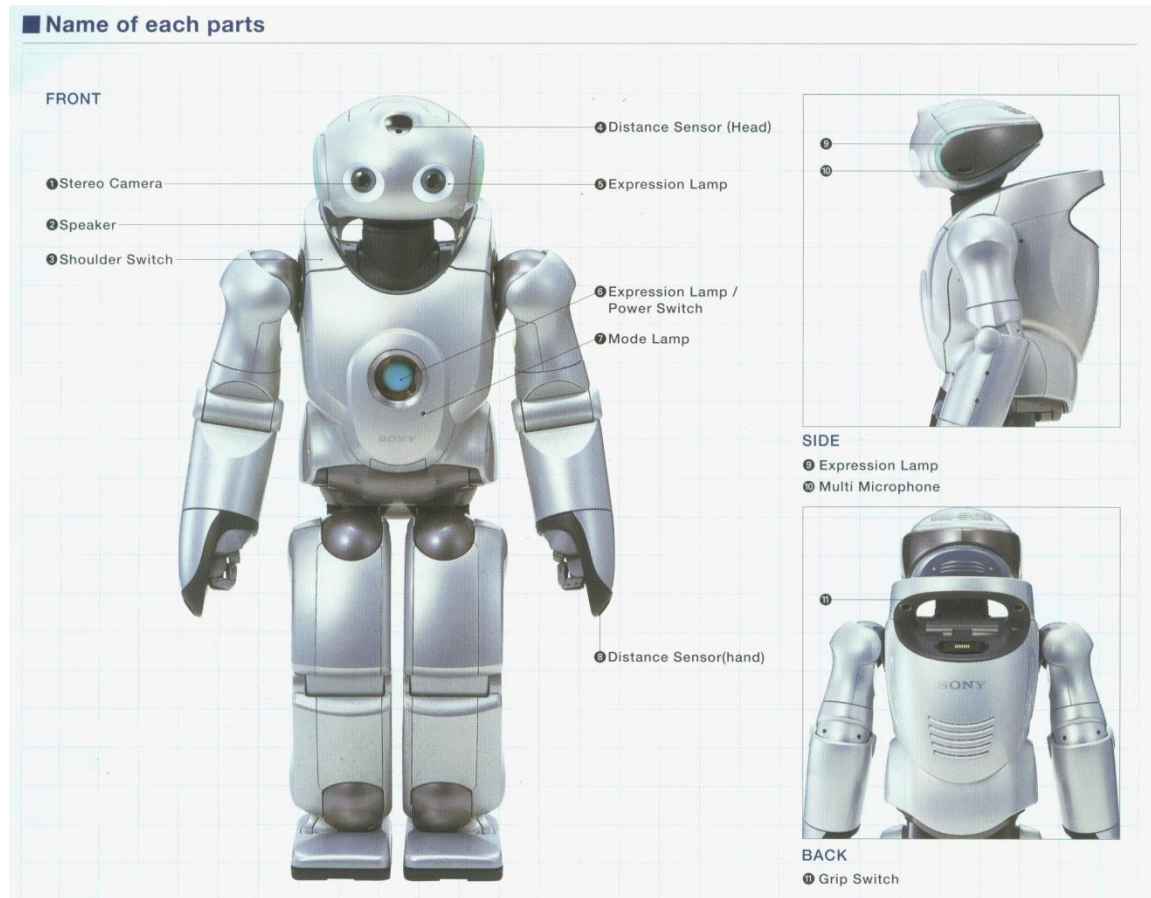

# TOYOTA

- How to do the human intelligence ?
- Here we go !

# Industrial Robots: Show time !

- Fast Moving (created by Philips 15 years ago): How it works ?
- ABB Robots Automation for CRT

# Can you Keep a Secret ?

- Before Commercial : designing and test
- Human with Robots
- Intelligent Enough ?
- More Compliance !
- Emotion ?

影片：宇多田 Can you keep scret